

CH-7B ③

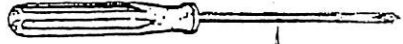

19473

N 1124

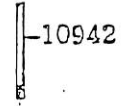
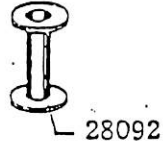
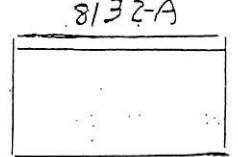

8132-A



13079-A



8121



8120



8118



8125

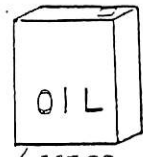

OIL

11193

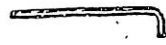

- 19457 (2.5m/m)
- 19458 (3m/m)
- 19459 (4m/m)
- 19460 (5m/m)
- 1871 (6m/m)

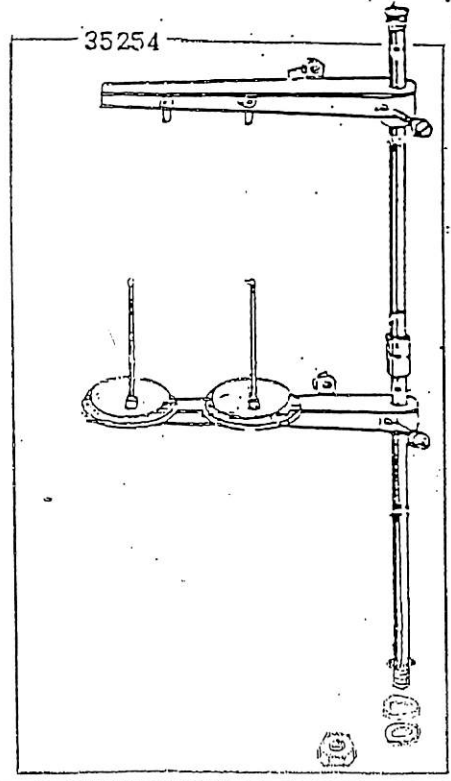
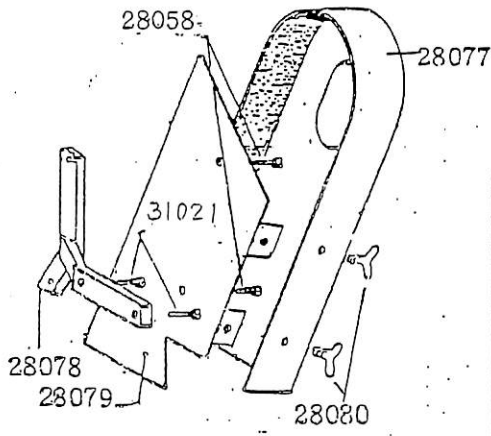

28006

28008

28007